

OUTRIGGER SPREADS & LOADS

FRONT
Outrigger Spread 19 ft 8 in

REAR
Outrigger Spread 24 ft 7 in

FRONT TO REAR
Outrigger Length 23 ft 4 in

MAX FRONT
Outrigger Load 43,383 lbf

MAX REAR
Outrigger Load 47,210 lbf

All dimensions and weights are approximate.

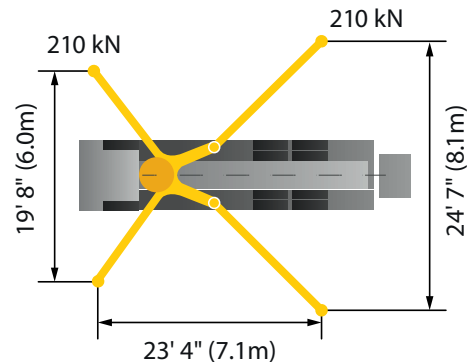

All of our concrete pump operators are **trained and certified** to maintain the highest safety standards and achieve the highest degree of professionalism, ensuring your pours are completed safely and efficiently.