

OUTRIGGER SPREADS & LOADS

FRONT
Outrigger Spread 29 ft 3 in

REAR
Outrigger Spread 34 ft 4 in

FRONT TO REAR
Outrigger Length 35 ft 4 in

MAX FRONT
Outrigger Load 76,435 lbf

MAX REAR
Outrigger Load 67,443 lbf

All dimensions and weights are approximate.

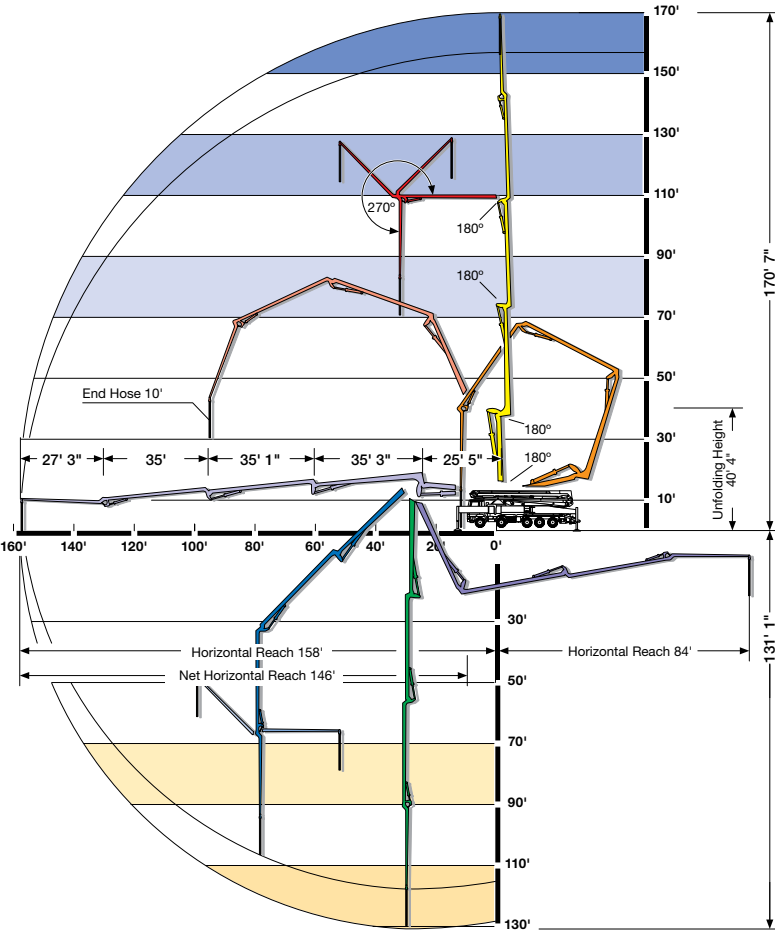
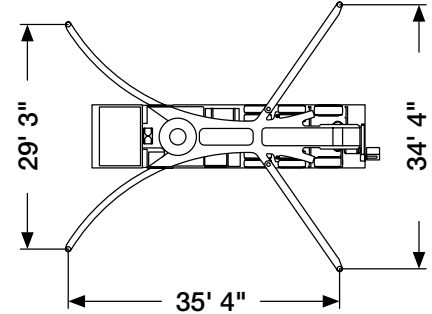

Booms over 47-Meters have high ground soil pressures that often require additional dunnage. We have the **expertise to set big booms up properly**, providing a safe work zone for everyone on the job site. Steel plates, crane pads or similar may need to be provided by the customer.