

OUTRIGGER SPREADS & LOADS

FRONT
Outrigger Spread 39 ft 8 in

REAR
Outrigger Spread 42 ft 1 in

FRONT TO REAR
Outrigger Length 42 ft 2 in

MAX FRONT
Outrigger Load 97,792 lbf

MAX REAR
Outrigger Load 95,544 lbf

All dimensions and weights are approximate.

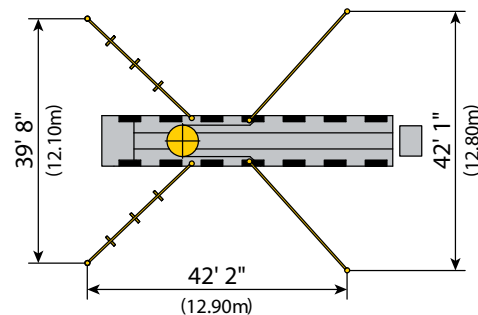

Booms over 47-Meters have high ground soil pressures that often require additional dunnage. We have the **expertise to set big booms up properly**, providing a safe work zone for everyone on the job site. Steel plates, crane pads or similar may need to be provided by the customer.